

Continuous Subglottic Suction Regulator

PM9100 Series



CONTENTS

RECEIVING / INSPECTION 2

INTENDED USE 2

READ ALL INSTRUCTIONS BEFORE USING..... 2

EXPLANATION OF ABBREVIATIONS 2

SAFETY INFORMATION - WARNINGS AND CAUTIONS 2

INSTALLATION..... 3

SPECIFICATIONS 3

COMPONENT IDENTIFICATION 5

OPERATING INSTRUCTIONS 6

CLEANING / DECONTAMINATION..... 7

MAINTENANCE 9

RETURNS 9

DISPOSAL INSTRUCTIONS 9

TROUBLESHOOTING..... 10

LIMITED WARRANTY AND LIMITATION OF LIABILITY 11

RECEIVING / INSPECTION

Remove the Precision Medical, Inc. *PM9100 Continuous Subglottic Suction Regulator* from the packaging and inspect for damage. If there is any damage, **DO NOT USE** and contact your Provider.

INTENDED USE

The *PM9100 Continuous Subglottic Suction Regulator* is intended to control the amount of vacuum from a central vacuum system that is to be delivered to devices designed to continuously aspirate subglottic secretions.

READ ALL INSTRUCTIONS BEFORE USING

This manual instructs a Professional to install and operate the *PM9100 Continuous Subglottic Suction Regulator*. This is provided for your safety and to prevent damage to the *Continuous Subglottic Suction Regulator*. If you do not understand this manual, **DO NOT USE** the *Continuous Subglottic Suction Regulator* and contact your Provider.

EXPLANATION OF ABBREVIATIONS

lpm	Liters Per Minute
mmHg	Millimeters of Mercury
inHg	Inches of Mercury

SAFETY INFORMATION - WARNINGS AND CAUTIONS

 **WARNING** Indicates a potentially hazardous situation which, if not avoided, could result in death or serious injury.

 **CAUTION** Indicates a potentially hazardous situation which, if not avoided, may result in minor or moderate injury.

 **CAUTION** Used without the safety alert symbol indicates a potentially hazardous situation which, if not avoided, may result in property damage.



CONSULT ACCOMPANYING DOCUMENTS

⚠WARNING

DO NOT use this *Continuous Subglottic Suction Regulator* for anything other than its Intended Use. Personal injury and / or damage to Regulator may result from misuse.

Only personnel instructed and trained in its use should operate this *Continuous Subglottic Suction Regulator*.

INSTALLATION

The PM9100 Continuous Subglottic Suction Regulator has a 1/8" NPT female inlet connection on the back of the regulator. There are two (2) configurations available for purchase.

1. The PM9100 connected directly to the wall suction outlet via a Precision Medical, Inc. 90° elbow and user specified fitting.
2. The PM9100 interfaced with an existing vacuum regulator using a Precision Medical, Inc. street tee (Part# 7032) and user specified fitting.
 - a. Install street tee to back of existing vacuum regulator. Ensure the outlet of the tee is pointing in the direction that the regulator is to be mounted.
 - b. Install Hex connector with regulator attached to street tee.
 - c. Install suction fitting to street tee.
 - d. Test connections to ensure they are leak free. Leaks may effect the performance accuracy of the PM9100 Continuous Subglottic Suction Regulator.

SPECIFICATIONS

Dimensions:

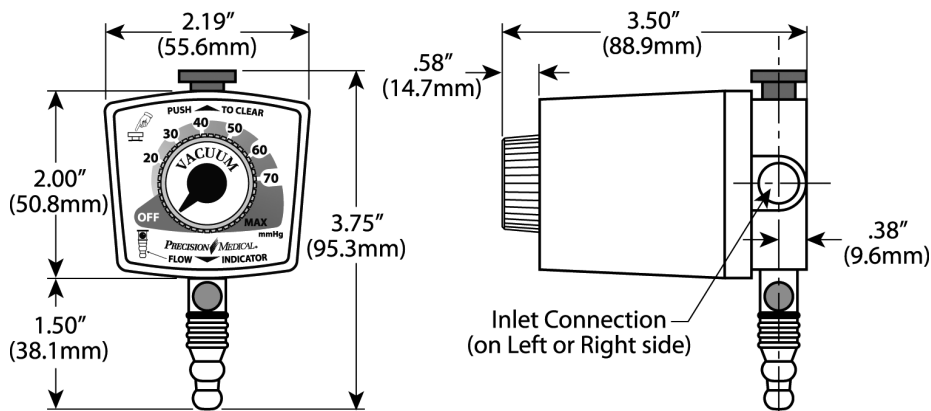

SPECIFICATIONS continued

Weight: 0.38 lbs (1.7 kg)
Shipping Weight: 0.53 lbs (0.24 kg)
Setting Range for PM9100 Series: 20-70 mmHg

Vacuum Ports:

Vacuum Connection: 1/8" NPT
Patient Connection: 1/4" Hose Barb with Flow Indicator

Operation: OFF - No Vacuum
REG. - (Regulated) provides an adjustable, continuous vacuum level

PUSH TO CLEAR - Temporarily increases vacuum level to line vacuum.

Flow:

<i>Model</i>	<i>Mode</i>	<i>Max Flow</i>
PM9100 Series	REG	13 lpm @ 20 mmHg up to 85 mmHg
	20-85 mmHg	37 lpm @ MAX of 85 mmHg
	Push to Clear	54 lpm

MAXIMUM FLOW IS MEASURED @ A VACUUM SOURCE OF 21 inHg

Maximum Vacuum PM9100 Series: REG. Mode 78-85 mmHg

Operating Environmental Limits: 0°F to 122°F (-18°C to 50°C)

Recommended Environmental Operating Limits: 55°F to 85°F (13°C to 29°C)

Storage Environmental Limits:

Temperature Range: -4°F to 140°F (-20°C to 60°C)

Humidity: Max 95% Noncondensing

Specifications are subject to change without prior notice.

COMPONENT IDENTIFICATION

⚠ CAUTION

Missing or illegible labels must be replaced, contact Precision Medical, Inc.

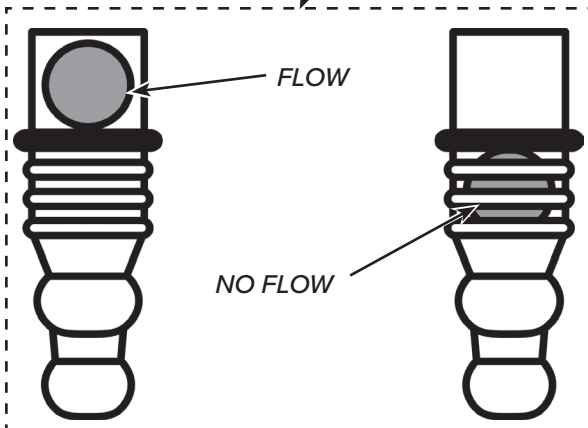
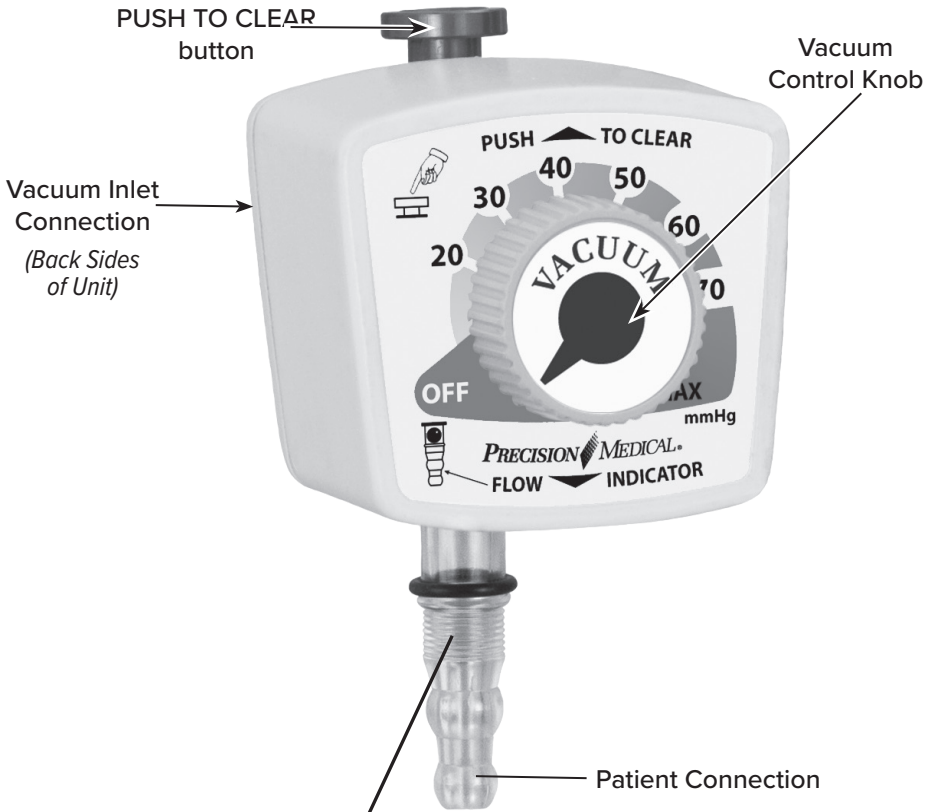

OPERATING INSTRUCTIONS

CAUTION

Inspect the *Continuous Subglottic Suction Regulator* for visual damage, DO NOT USE if damaged.

NOTE: *Overflow protection must be used with the PM9100 Subglottic Suction Regulator. (i.e. Filter; Precision Medical Part# 1690, Canister equipped with shut off).*

1. Turn the Vacuum Control Knob to the “OFF” position. Knob must be turned *counterclockwise* until knob reaches the stop.
2. Attach the Suction Regulator to the vacuum source. (Subglottic suction regulator may be used independently or in combination with a standard suction regulator).

A. REG MODE (Regulated Mode)

1. Turn the Vacuum Control Knob to the manufacturers recommended suction level for the device being used to accomplish continuous subglottic suction of secretions. (Typically 15-30 mmHg)

NOTE: *Vacuum setting must be increased approximately 20 mmHg for each 12” that the suction Collection Canister is located above patient level.*

2. Block the bottom port of the PM9100 to verify flow indicator ball disappears from view. (*No Flow Condition*)
3. Using the Vacuum Control Knob, set the desired vacuum. (Scale is calibrated for occluded pressures).
To **INCREASE** vacuum - Turn Knob **CLOCKWISE**
To **DECREASE** vacuum - Turn Knob **COUNTERCLOCKWISE**
4. Verify vacuum pressure setting with PM760 (Digital Vacuum Check Unit).

B. PUSH TO CLEAR MODE (Full, unregulated vacuum)

The PM9100 Continuous Subglottic Suction Regulator incorporates a unique flow monitoring mechanism for visual indication to determine the lumen patency of the subglottic suction device.

⚠WARNING

The PUSH TO CLEAR button should never be depressed for longer than 15 seconds as injury to the patient may occur.

The PM9100 Subglottic Suction Regulator must be serviced if the PUSH TO CLEAR button fails to return to its original position.

1. Depress PUSH TO CLEAR button for 1-5 seconds at a time and observe flow indicator to determine if clog is cleared from port or tube.
2. If blockage is not removed, follow device manufacturers recommendations for clearing the subglottic port or tube.
3. Turn the Vacuum Control Knob to the “OFF” position to turn the Regulator off. Knob must be turned *counterclockwise* until knob reaches stop and ball falls.

⚠CAUTION

DO NOT operate the PM9100 when the collection canister is “full”. This may cause loss of vacuum and damage to the Suction Regulator. ***This will void the warranty.***

CLEANING / DECONTAMINATION (As needed)

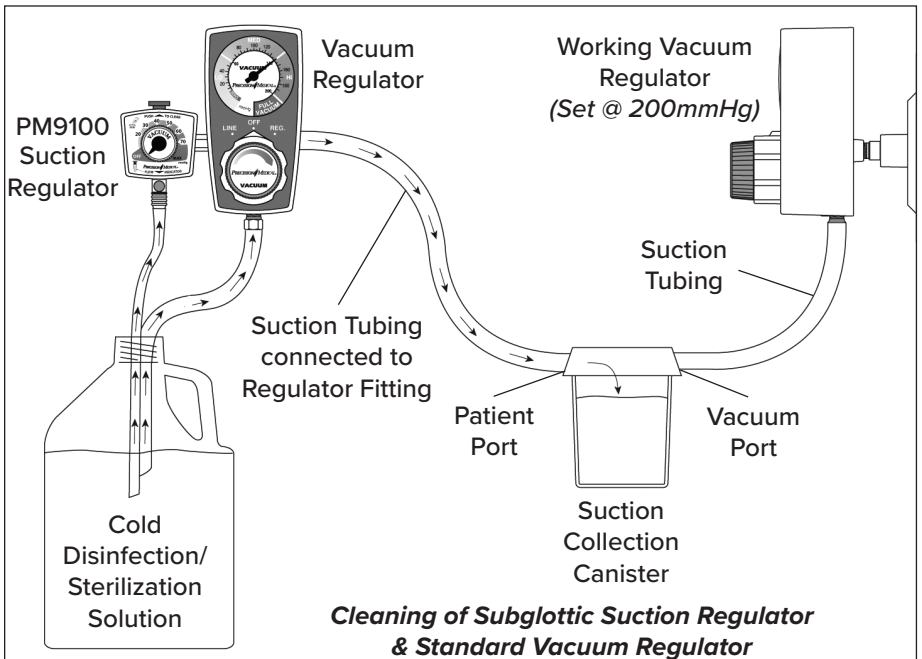
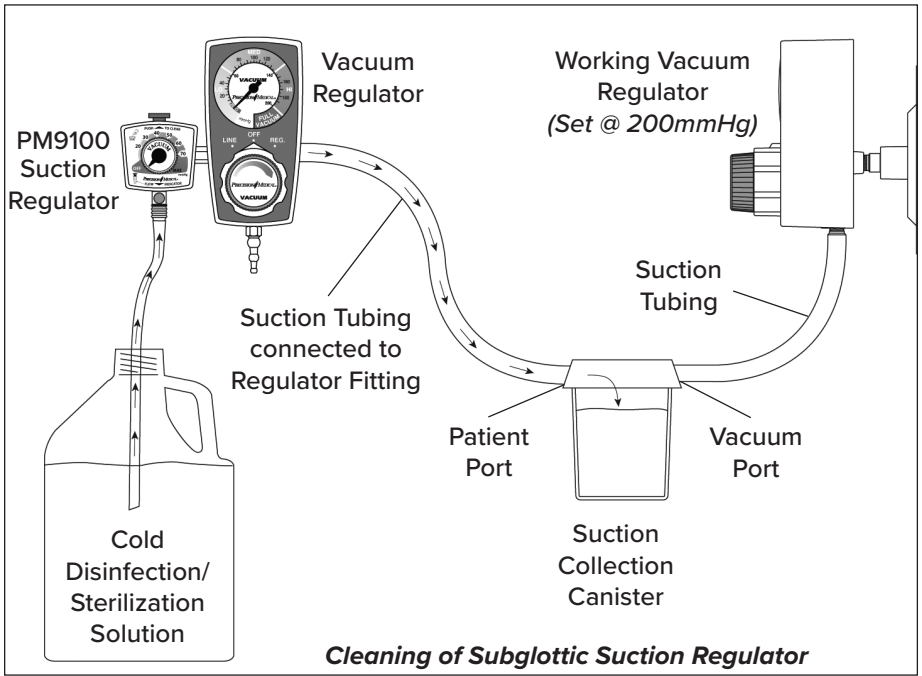

External Cleaning

1. Disconnect all gas connections and equipment before cleaning.
2. Clean exterior surfaces using Super Sani-Cloth germicidal disposable wipes. Remove all visible contamination from the external surfaces of the device and its accessories. Be sure to closely inspect and remove contamination from seams and recesses on the device that may trap contaminants. Wipe with clean paper towel to remove debris.
3. After all visible contamination is removed; use a second germicidal wipe to thoroughly wet the surfaces of the device and accessories. Allow to remain wet for 4 minutes. Use additional wipes if needed to assure surfaces are wetted continuously for 4 minutes.
4. Allow device to air dry completely.
5. Visually inspect the device for visible contamination. Repeat cleaning/ disinfection process if necessary.

WARNING

DO NOT autoclave or immerse in liquid. This will cause damage to the Suction Regulator and will **void the warranty**.

If Vacuum Regulator becomes internally contaminated, warranty is voided, **DO NOT** send back to Precision Medical, Inc. for repair. Follow your facilities contaminated equipment protocol.

This Suction Regulator contains magnetic, ferrous material that may affect the results of an MRI.

Be sure all connections are tight and leak free.

1. Attach a working Vacuum Regulator with a continuous regulated mode to a minimum vacuum level of 200 mmHg.
2. Mix cold disinfection / sterilization solution according to its manufacturers directions.
3. Connect tubing as shown in “CLEANING / DECONTAMINATION” on previous page.
4. Adjust the Suction Regulator(s) to be cleaned on the continuous regulated mode.
5. Adjust the vacuum to a minimum of 60 mmHg.
6. Depress PUSH TO CLEAR button and hold for 10 seconds.
7. Allow cold disinfection / sterilization solution to pass through and collect in Suction Canister. Procedure should continue for time recommended by the manufacturer of the cold disinfection / sterilization solution for the desired level of disinfection or sterilization.
8. Set vacuum control knob to zero and clamp off suction tubing so solution does not flow out.

9. Allow cold disinfection solution to remain inside regulator for recommended time to achieve desired level of disinfection.

Rinse: Sterile or Potable Water

10. Adjust the Suction Regulator(s) to be cleaned to a minimum of 60 mmHg.
11. Allow remaining cold disinfection / sterilization solution to pass through and collect in Suction Canister occasionally depressing and holding the PUSH TO CLEAR button. *(Repeat rinse according to Disinfectant Manufacturers Recommendations).*
12. Thoroughly dry the internal components by drawing maximum vacuum through the Suction Regulator to be cleaned for at least 30 seconds.

Note: *If it is not possible to pass cold disinfection / sterilization solution through the Suction Regulator, then the passageways are totally blocked and DISASSEMBLY of the Suction Regulator is required. Please contact your Precision Medical, Inc. Sales Representative. Be sure to follow your facility's Biohazard protocol.*

MAINTENANCE

Before each use visually inspect *Continuous Subglottic Suction Regulator* for any sign of damage, **DO NOT USE** if damaged.

Replace the filter every 1 year or as necessary to prevent clogging

RETURNS

Returned products require a Returned Goods Authorization (RGA) Number, contact Precision Medical, Inc. All returns must be packaged in sealed containers to prevent damage. Precision Medical, Inc. will not be responsible for goods damaged in transit. Refer to Precision Medical, Inc. Return Policy available on the Internet, www.precisionmedical.com.

Manuals available on our website: www.precisionmedical.com

DISPOSAL INSTRUCTIONS

Dispose of the *Continuous Subglottic Suction Regulator* in accordance with the local regulations.

Please Recycle



⚠WARNING

Product should be cleaned before being disposed of. Potential for Biohazard.

TROUBLESHOOTING

If the Suction Regulator fails to function, consult the Troubleshooting Table. If problem cannot be solved, consult your Provider.

Problem	Probable Cause	Remedy
No vacuum at bottom port (float ball not visible)	<ul style="list-style-type: none"> • Regulator turned “OFF” • Loose connection • Subglottic port / tube clogged • Collection Container full • No vacuum to Regulator • Clogged vacuum Port 	<ul style="list-style-type: none"> • Adjust Vacuum Control Regulator knob • Tighten connection • Refer to manufacturers recommendation to unclog • Replace Container • Connect to a known working vacuum source • Disassemble and clean
Float Ball will not return to No Flow position	<ul style="list-style-type: none"> • Float ball wet • Defective flow indicator 	<ul style="list-style-type: none"> • Set vacuum level to maximum and allow to dry • Contact Precision Medical, Inc. for repair
Vacuum Regulator erratic	<ul style="list-style-type: none"> • Dirty Regulator Module • Defective Regulator Module 	<ul style="list-style-type: none"> • Clean Regulator per Cleaning Instructions • Contact Precision Medical, Inc. for repair
Stiff movement of Vacuum Control Knob	<ul style="list-style-type: none"> • Dirty Regulator Module 	<ul style="list-style-type: none"> • Clean Regulator per Cleaning Instructions
Set Vacuum Level is not accurate	<ul style="list-style-type: none"> • Dirty Regulator Module • Filter is clogged 	<ul style="list-style-type: none"> • Clean Regulator per Cleaning Instructions • Replace Filter

Replacement Filter (10-pack): Part # 1396-10

LIMITED WARRANTY AND LIMITATION OF LIABILITY

Precision Medical, Inc. warrants that *Continuous Subglottic Suction Regulator* (the Product) will be free of defects in workmanship and/or material for the following period:

Two (2) years from shipment

Should any failure to conform to this warranty appear within the applicable period, Precision Medical, Inc. shall, upon written notification thereof and substantiation that the goods have been stored, installed, maintained and operated in accordance with Precision Medical, Inc.'s instructions and standard industry practice, and that no modifications, substitutions, or alterations have been made to the goods, correct such defect by suitable repair or replacement at its own expense.

ORAL STATEMENTS DO NOT CONSTITUTE WARRANTIES.

The representatives of Precision Medical, Inc. or any retailers are not authorized to make oral warranties about the merchandise described in this contract, and any such statements shall not be relied upon and are not part of the contract for sale. Thus, this writing is a final, complete and exclusive statement of the terms of that contract.

THIS WARRANTY IS EXCLUSIVE AND IS IN LIEU OF ANY WARRANTY OF MERCHANTABILITY, FITNESS FOR A PARTICULAR PURPOSE OR OTHER WARRANTY OF QUALITY, WHETHER EXPRESS OR IMPLIED.

Precision Medical, Inc. shall not under any circumstances be liable for special, incidental or consequential damages including but not limited to lost profits, lost sales, or injury to person or property. Correction of non-conformities as provided above shall constitute fulfillment of all liabilities of Precision Medical, Inc. whether based on contract, negligence, strict tort or otherwise.

Precision Medical, Inc. reserves the right to discontinue manufacture of any product or change product materials, designs, or specifications without notice.

Precision Medical, Inc. reserves the right to correct clerical or typographical errors without penalty.



300 Held Drive
Northampton PA 18067, USA

www.precisionmedical.com

T: (+001) 610-262-6090 • F: (+001) 610-262-6080

ISO 13485 Certified